

CHAMPION

POWER EQUIPMENT

TM-MC

OWNER'S MANUAL



4700 lb. Winch ATV/UTV Winch Kit



MODEL NUMBER

100129

SAVE THESE INSTRUCTIONS
Important Safety Instructions
are included in this manual.

MADE IN CHINA
REV 100129-20180803

12039 Smith Ave.
Santa Fe Springs CA 90670
USA / 1-877-338-0999
www.championpowerequipment.com

Have questions or need assistance?

Do not return this product to the store!

WE ARE HERE TO HELP!

Visit our website:

www.championpowerequipment.com

for more info:

- Product Info & Updates
- Tech Bulletins
- Frequently Asked Questions
- Product Registration

– or –

Call our Customer Care Team Toll-Free at:

1-877-338-0999

Parts Ordering:

Mon – Fri 8:30 AM – 5:00 PM (PST/PDT)

Toll Free: 1-877-338-0999

WARNING: Cancer and Reproductive Harm – www.P65Warnings.ca.gov

*We are always working to improve our products. Therefore, the enclosed product may differ slightly from the image on the cover.

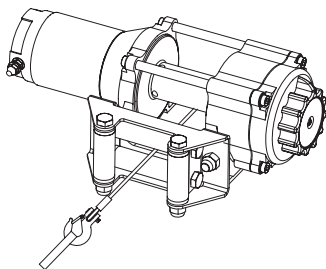

4700 lb. Winch ATV/UTV Winch Kit

TABLE OF CONTENTS

Introduction	1	Maintenance	11
Introduction	1	Lubrication	11
Manual Conventions	2	Cable Assembly Replacement	11
Safety Rules	3	Specifications	12
Controls and Features	5	Performance Specifications	12
Winch	5	Parts Diagram	13
Assembly	6	Parts List	14
Assembling the Winch	6	Troubleshooting	15
Mounting the Remote Control	6		
Winch Wiring	7		
Wiring Diagram	8		
Operation	9		
General Tips for Safe Operation	9		
Self Recovery	9		
Winching Techniques A-Z	10		

INTRODUCTION

Introduction

Congratulations on your purchase of a Champion Power Equipment product. Champion Power Equipment and Champion Engine Technology designs, builds, and supports all of our products to strict specifications and guidelines. With proper product knowledge, safe use, and regular maintenance, this product should bring years of satisfying service.

Every effort has been made to ensure the accuracy and completeness of the information in this manual, and we reserve the right to change, alter and/or improve the product and this document at any time without prior notice.

Since CPE/CET highly value how our products are designed, manufactured, operated and are serviced, and also highly value your safety and the safety of others, we would like you to take the time to review this product manual and other product materials thoroughly and be fully aware and knowledgeable of the assembly, operation, dangers and maintenance of the product before use. Fully familiarize yourself, and make sure others who plan on operating the product fully familiarize themselves too, with the proper safety and operation procedures before each use. Please always exercise common sense and always error on the side of caution when operating the product to ensure no accidents, property damage, or injury occurs. We want you to continue to use and be satisfied with your CPE/CET product for years to come.

Record the model and serial numbers as well as date and place of purchase for future reference. Have this information available when ordering parts and when making technical or warranty inquiries.

Champion Power Equipment Support
1-877-338-0999
Model Number
100129
Serial Number
Date of Purchase
Purchase Location

This manual uses the following symbols to help differentiate between different kinds of information. The safety symbol is used with a key word to alert you to potential hazards in operating and owning power equipment.

Follow all safety messages to avoid or reduce the risk of serious injury or death.

 **DANGER**

DANGER indicates an imminently hazardous situation which, if not avoided, **will** result in death or serious injury.

 **WARNING**

WARNING indicates a potentially hazardous situation which, if not avoided, **could** result in death or serious injury.

 **CAUTION**

CAUTION indicates a potentially hazardous situation which, if not avoided, **may** result in minor or moderate injury.

CAUTION

CAUTION used without the safety alert symbol indicates a potentially hazardous situation which, if not avoided, **may** result in property damage.

 **NOTE**

If you have questions regarding your winch, we can help. Please call our help line at **1-877-338-0999**

SAFETY RULES

WARNING

Read this manual thoroughly before operating your winch. Failure to follow instructions could result in serious injury or death.

WARNING

Do not exceed the rated capacity.

DANGER

Do not use this winch for lifting or moving people or animals.

DANGER

Keep yourself and others a safe distance to the side of the cable when under tension.

DANGER

Never step over a cable or near a cable under load.

WARNING

The cable may break before the motor stalls. For heavy loads at or near rated capacity, use a pulley block/snatch block to reduce the load on the cable.

WARNING

Do not move the vehicle to pull a load (towing) on the winch cable. This could result in cable breakage.

WARNING

Pull only on areas of the vehicle as specified by the vehicle manufacturer.

WARNING

Do not use the winch to secure or hold a vehicle for a long period of time. Do not use the winch to secure a vehicle for transport.

WARNING

Disconnect the remote control and battery leads when not in use.

WARNING

Avoid “shock loads” by using the control switch intermittently to take up the slack in the cable. “Shock loads” can far exceed the rate capacity for the cable and drum.

Do not accelerate your vehicle while winching. Loss of traction can cause a shock load on the cable.

WARNING

Batteries contain acid and produce explosive gases.

Keep sparks, flames and cigarettes away from batteries at all times. Wear safety glasses and protect the eyes at all times. Do not lean over the batteries during operation.

⚠ WARNING

When re-spooling the cable, ensure that the cable spools in the under-wind position with the cable entering the drum from the bottom, not the top.

To re-spool correctly, and while wearing gloves, keep a slight load on the cable while pushing the remote button to draw in the cable. Walk toward the winch not allowing the cable to slide through your hands. Do not let your hands get within 12 in. (30.5 cm) of the winch while re-spooling. Turn off the winch and repeat the procedure until a few feet of cable are left. Disconnect the remote control and finish spooling by rotating the drum by hand with the clutch disengaged. Keep hands clear of the fairlead and drum while the winch is under power.

⚠ WARNING

Do not use as a hoist. Do not use for overhead lifting.

⚠ CAUTION

Use gloves to protect hands when handling the cable. Never let the cable slide through your hands.

⚠ CAUTION

Do not wrap the cable around any object and hook it back onto itself.

⚠ CAUTION

Apply blocks to the wheels of the vehicle when on an incline.

⚠ CAUTION

Duration of winching pulls should be kept as short as possible.

If the motor becomes uncomfortably hot to the touch, stop winching immediately and let it cool down for a few minutes. Do not pull for more than one minute at or near the rated load.

⚠ CAUTION

If the motor stalls, do not maintain power to the winch.

Electric winches are designed and made for intermittent use and should not be used in constant duty applications.

⚠ CAUTION

Never release the free-spool clutch when there is a load on the winch.

⚠ CAUTION

Use hook strap when handling the hook for spooling or unspooling the cable.

CONTROLS AND FEATURES

Read this owner's manual before operating your winch. Familiarize yourself with the location and function of the controls and features. Save this manual for future reference.

Winch

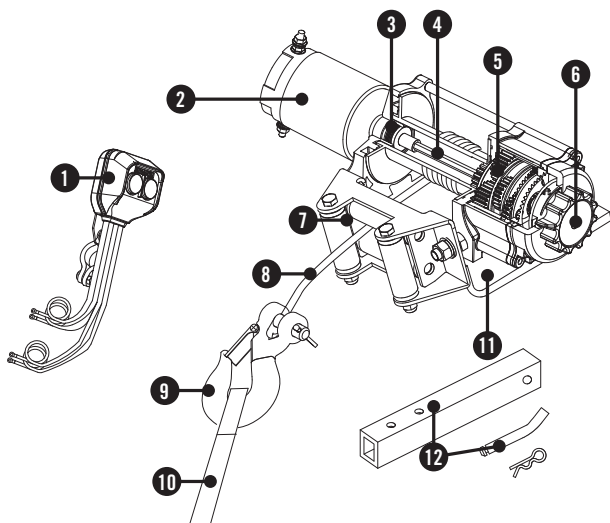

- (1) **Remote Control** – Powers the cable in or out of your winch drum.
- (2) **Motor** – 1.6 HP / 1.2 kW 12V DC motor provides power to the planetary gear mechanism.
- (3) **Braking System** – Braking action is automatically applied to the winch drum when the winch motor is stopped and there is a load on the cable.
- (4) **Winch Drum** – The winch drum is the cylinder on which the cable is stored. It can feed or wind the cable depending on the remote winch switch.
- (5) **Planetary Gear System** – The reduction gears convert the winch motor power into extreme pulling forces. This system allows high torque while maintaining compact size and light weight.
- (6) **Free Spooling Clutch** – The clutch allows the operator to manually disengage “Out” the spooling drum from the gear train, free spool. Engaging the clutch “In” locks the winch into the gear system.
- (7) **Roller Fairlead** – When using the winch at an angle the roller fairlead acts to guide the cable onto the drum and minimizes damage to the cable from abrasion on the winch mount or bumper.
- (8) **Wire Cable** – 15/64 in. x 38 ft. (6 mm x 11.6 m) galvanized aircraft cable designed specifically for load capacity of 4700 lb. (2132 kg).
- (9) **Clevis Hook** – Provides a means for connecting the looped ends of cables to an anchor.
- (10) **Strap** – Used to assist cable feed.
- (11) **Mount Assembly** – Flatbed mounting channel.
- (12) **1.25 in. Hitch Adapter Assembly** – Adapter for front or rear end hitch receiver mounting and off-vehicle storage.

Assembling the Winch

This CPE 4700 lb. (2132 kg) winch is designed with a bolt pattern that is standard in this class of winch. Many winch mounting kits are available that utilize this bolt pattern for the most popular UTVs and ATVs. If you cannot find a kit locally, contact CPE and we will provide you with the name of a dealer.

! CAUTION

Mounting bolts must be SAE grade 5 or better and torque to 34 ft. lbs.

1. Insert M10x20 bolts through the mounting channel holes and attach the roller fairlead to the mounting channel with the M10 lock nuts provided.

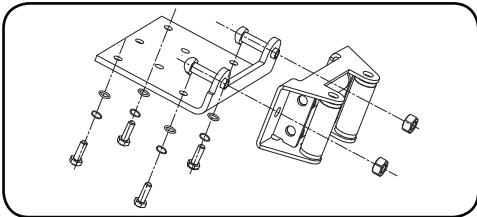

2. Turn the winch upside down. Place the mounting channel on the winch, making sure the winch is centered in the middle of it.
3. Thread the M8x25 bolts through the M8 flat and locker washers, and then thread through the mounting channel. Tighten the bolts. DO NOT over tighten.
4. Turn winch right side up. Disengage the clutch by moving the Cam Ring to the "Out" position. Release the cable and pull through the roller fairlead.
5. Attach the clevis hook to the cable, and then hand strap to the clevis hook.

Assembling the Winch Cont'd.

CAUTION

If utilizing a mounting plate, ensure that the three major sections (motor, drum and gear housing) are properly aligned. Proper alignment of the winch will allow for even distribution of the full rated load.

NOTE

The type of vehicle to which the winch and mounting channel will be applied, will dictate the type of mounting kit that should be used (Speed Mount™ Hitch Adapter, Standard Mounting Channel, or Specialty Mounting Kit).

Mounting the Remote control

1. The remote control is usually installed on the left handlebar.
2. Use a piece of electrical tape around the handlebar to help prevent rotation of the mount on the handlebar. Do NOT tighten over any hoses or cables.
3. Once the remote control is mounted you can route the wires back to the battery and winch.
4. Make sure the handlebars have full range of motion and then secure the remote control's cable.

ASSEMBLY

Winch Wiring

! CAUTION

Never route electrical cables across any sharp edges, through or near moving parts, or near parts that become hot.

1. Mount the winch to your vehicle.
2. FOR WINCH TO FULLY FUNCTION CONNECT ALL LEADS CORRECTLY.
3. Connect the battery leads: Connect the red (+) lead to the positive (+) terminal of the vehicle's 12 volt battery. Connect the black (-) lead to the negative (-) terminal of the vehicle's 12 volt battery. (see wiring diagram)
4. Connect the winch leads: Connect red (+) lead of the winch connection cables to the positive (+) terminal of the winch motor. Connect the black (-) lead of the winch connection cables to the negative (-) terminal of the winch motor. (see wiring diagram)
5. Check for proper drum rotation. Pull and turn the clutch knob to the "out" position (Free spooling). Pull out some cable from the drum, and then turn the clutch knob to the "In" position to engage the gears. Press the cable out button on the handlebar switch. If the drum is turning and releasing more cable then your connections are accurate. If the drum is turning and collecting more cable then reverse the leads on the motor. Repeat and check rotation.

! CAUTION

Battery cables should not be drawn taut. Leave some slack for cable movement.

Winch Wiring Cont'd.

With some applications the motor leads may need to be rotated to avoid interference with other components.

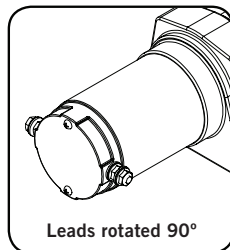
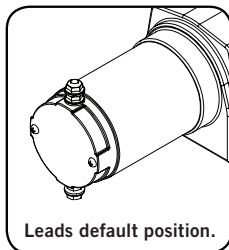

Wiring Diagram

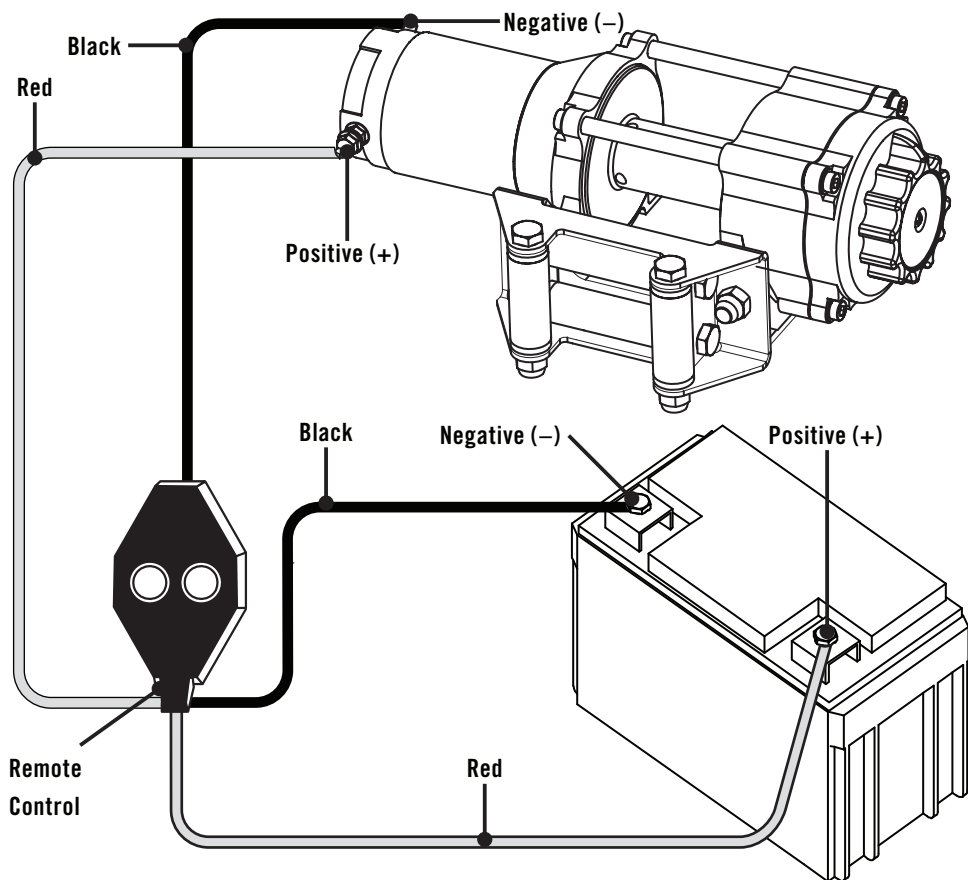

OPERATION

General Tips for Safe Operation

Your 100129 winch is rated at a 4700 lb. (2132 kg) capacity in first layer (max) when spooling the first cable layer on the drum. Overloads can damage the winch, motor and/or cable. For loads over 2350 lb. (1066 kg) we recommend the use of the pulley block/snatch block to double the cable line. This will aid in two ways:

- reduce the number or cable layers on the drum, as well as,
- reduce the load on the cable by as much as 50%.

When doubling the line back to the vehicle, attach to the tow hook, frame or other load bearing part. The vehicle engine should be kept running during operation of the winch to minimize battery drain and maximize power and speed of the winch. If the winch is used for a considerable time with the engine off the battery may be drained and too weak to restart the engine.

Get to know your winch before you actually need to use it. We recommend that you set up a few test runs to familiarize yourself with rigging techniques, the sounds your winch makes under various loads, the way the cable spools on the drum, etc.

Inspect the cable and equipment before each use. A frayed or damaged cable shall be replaced immediately. Use only manufacturer's identical replacement cable with the exact specifications.

Inspect the winch installation and bolts to ensure that all bolts are tight before each operation. Store the remote control inside your vehicle in a place that it will not be damaged.

Any winch that appears to be damaged in any way, is found to be worn, or operates abnormally **MUST BE REMOVED FROM SERVICE UNTIL REPAIRED**. It is recommended that the necessary repairs be made by a manufacturer's authorized repair facility. Pull only on areas of the vehicle as specified by the vehicle manufacturer. Only attachments and/or adapters supplied by the manufacturer are to be used.

Self Recovery

Locate a suitable anchor such as a strong tree trunk or boulder. Always use a sling as an anchor point.

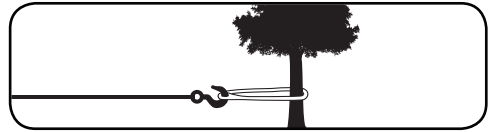

A roller fairlead (included) will help guide the cable and to reduce binding on short side pulls. Do not winch from an acute angle as the cable will pile up on one side of the drum causing damage to cable and the winch.

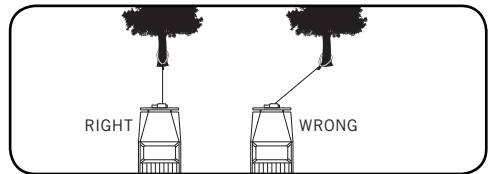

Short pulls from an angle can be used to straighten the vehicle. Long pulls should be done with the cable at a 90° angle to the winch/vehicle.

When pulling a heavy load, place a blanket or jacket over the cable 5 ft. or 6 ft. (1.5 m to 1.8 m) from the hook.

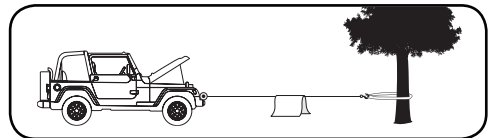

In the event of a broken cable it will dampen the snap back. For additional protection open the hood of the vehicle. For pulls over 2350 lb. (1066 kg), we recommend the use of the snatch block/pulley block to double line the cable. (not included)

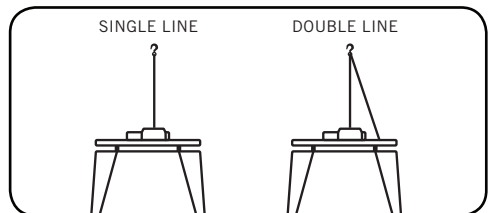

This reduces the load on the winch and the strain on the cable by approximately 50%.

Winching Techniques A-Z

- (a) Take time to assess your situation and plan your pull.
- (b) Put on gloves to protect your hands.
- (c) Disengage the clutch to allow free- spooling and also save battery power.
- (d) Attach the hook strap to the clevis hook.
- (e) Pull out the cable to your desired anchor point using the hook strap.
- (f) Secure the clevis hook to the anchor point: Sling, chain or snatch block. Do not attach the hook back onto the cable.
- (g) Engage the clutch.
- (h) Connect the remote control to the winch. If you are going to control the winch from inside your vehicle then pass the remote through an open window to avoid the wires being pinched in the door.
- (i) Start your engine to ensure power is being replenished to the battery.
- (j) Drape a blanket or jacket over the cable approximately 5 ft. to 6 ft. (1.5 m to 1.8 m) from the hook. Open the hood for added protection.
- (k) Power in the cable guiding the wire under tension to draw up the slack in the wire. Once the wire is under tension, stand clear. Never step over the cable.
- (l) Double check your anchors and make sure all connections are secure.
- (m) Inspect the cable. Make sure there are at least 5 wraps of cable around the winch drum.
- (n) Clear the area. Make sure all spectators stand clear and that no one is directly in front or behind the vehicle or anchor point.
- (o) Begin winching. Be sure that the cable is winding evenly and tightly around the drum. The vehicle that is being winched can be slowly driven to add assistance to the winching process. Avoid shock loads; keep the cable under tension.

Winching Techniques A-Z Cont'd.

- (p) The vehicle to be winched should be placed in neutral and the emergency brake released. Only release the brake pedal when under full tension. Avoid shock loads to the winch. This can damage the winch, cable and vehicle.
- (q) The winch is meant for intermittent use. Under full load with a single line rig do not power in for more than a minute without letting the motor cool down for a few minutes and then resume the winching operation.
- (r) The winching operation is complete once the vehicle is on stable ground and is able to drive under its own power.
- (s) Secure the vehicle. Be sure to set the brakes and place the vehicle in park.
- (t) Release the tension on the cable. The winch is not meant to hold the vehicle for long periods of time.
- (u) Disconnect the cable from the anchor.
- (v) Rewind the cable. Make sure that any wire already on the drum has spooled tightly and neatly. If not, draw out the wire and re-spool from the point where the cable is tight.
- (w) Keep your hands clear of the winch drum and fairlead as the cable is being drawn in.
- (x) Secure the hook and hook strap.
- (y) Disconnect the remote control and store in a clean, dry place.
- (z) Clean and inspect connections and mounting hardware for next winching operation.

MAINTENANCE

The owner/operator is responsible for all periodic maintenance.

WARNING

Never operate a damaged or defective winch.

WARNING

Improper maintenance will void your warranty.

Complete all scheduled maintenance in a timely manner. Correct any issue before operating the winch.

NOTE

For service or parts assistance, contact our help line at **1-877-338-0999**

Lubrication

All moving parts within the electric winch having been lubricated using high temperature lithium grease at the factory. No internal lubrication is required. Lubricate cable assembly periodically using a light penetrating oil.

Cable Assembly Replacement

It is recommended that any modifications be performed by a manufacturer's authorized repair facility, and that only manufacturer-supplied parts be used.

1. Move the clutch to the "Out" position.
2. Extend cable assembly to its full length. Note how the existing cable is connected to the inside of the drum.
3. Remove old cable assembly and attach new one.
4. Retract cable assembly onto drum being careful not to allow kinking.

Performance Specifications

- Rated Pull	4700 lb. (2132 kg)
- Gear Reduction Ratio	166:1
- Motor	Permanent Magnet 1.6 HP/1.2 kW (12V DC)
- Drum Size	2 in. (D) x 3.2 in. (L) [50.8 mm (D) x 81 mm (L)]
- Cable	15/64 in. (D) x 38 ft. (L) [6 mm (D) x 11.6 m (L)]
- Gross Weight	35.3 lb. (16 kg)
- Net Weight	32.2 lb. (14.6 kg)
- Height	5 in. (12.7 cm)
- Width	4.6 in. (11.6 cm)
- Length	14.6 in. (37.1 cm)
- Bolt Pattern	4.9 in. X 3 in. (12.4 cm X 7.6 cm)

Line Speed and Motor Current (First Layer)						
Line Pull	LB	0	1000	2000	3000	4700
	KG	0	454	907	1361	2132
Line Speed (12V DC)	FPM	12.8	9.8	8.5	6.9	3.9
	MPM	3.9	3.0	2.6	2.1	1.2
Motor Current (12V DC)	A	28	80	130	180	280
Running Time	Minutes	1	1	1	1	1
Cooling Time	Minutes	5	5	5	5	5

*If the motor becomes uncomfortably hot to the touch, stop winching immediately and let it cool down for 5 minutes. Do not pull for more than one minute at or near the rated load.

**Electric winches are designed and made for intermittent use and should not be used in constant duty applications.

Line Pull and Cable Capacity Per Layer					
Line of Cable		1	2	3	4
Rated Line Pull	LB	4700	3880	3304	2877
	KG	2132	1760	1499	1305
Cable Capacity	FT	8.5	19	31.2	38
	M	2.6	5.8	9.5	11.6

Parts Diagram

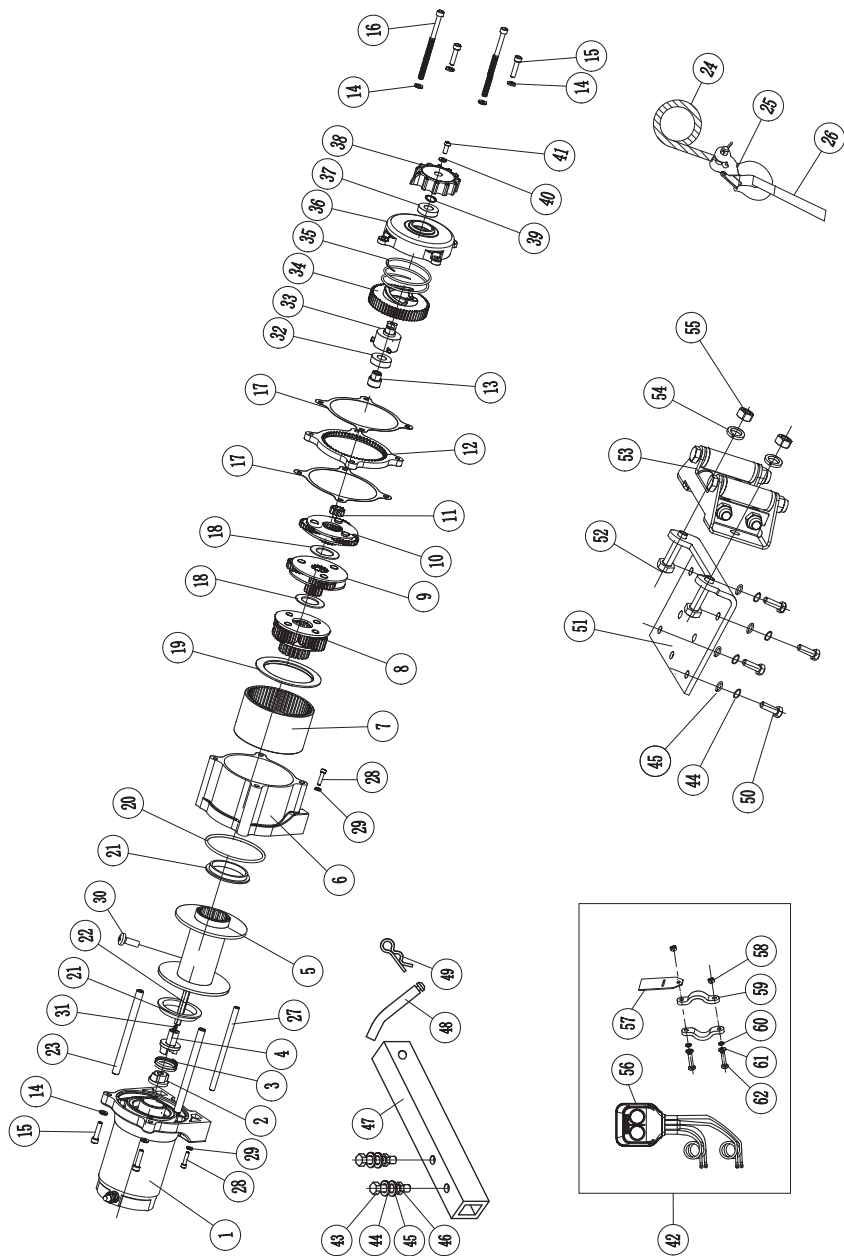

#	Part Number	Description	Qty
1	450100-BF	Motor - Black Flat	1
2	450001	Coupling, I	1
3	450002	Spring, Coupling	1
4	450003	Coupling, II	1
5	400200-BF	Drum Assembly - Black Flat	1
6	450004-BF	Gear Housing/End Bearing - Black Flat	1
7	450005-A	Gear Ring	1
8	450006	Gear Carrier Assembly, Output	1
9	450007	Gear Carrier Assembly, Intermediate	1
10	450008	Gear Carrier Assembly, Input	1
11	450009	Gear - Input, Sun	1
12	450010-BF	Gear, Fixed - Black Flat	1
13	250021	Clutch Bushing	1
14	250002	Washer Ø6, Flat	6
15	450011	Hexagon Socket Head Screw M6 x 25	4
16	450012	Hexagon Socket Head Screw M6 x 100	2
17	450013	Seal	2
18	450014	Friction Washer	2
19	450015	Retaining Ring	1
20	450016	O-Ring Seal	1
21	450017	Drum Bushing	2
22	450018	Hexagonal Shaft	1
23	400008	Tie Bar Ø10	2
24	450800	Cable Assembly	1
25	C20002	1/4 In. Clevis Hook	1
26	410022	Yellow Strap	1
27	400010	Tie Bar Ø8	1
28	450026	Hexagon Socket Head Screw M4 x 25	2
29	450027	Lock washer Ø4	2
30	450031	Cross Recessed Pan Head Screw M6 x 8	1
31	450029	Spring	1
32	GB2760BB06002-SS	Radial Ball Bearing 6002 Sealed	1

#	Part Number	Description	Qty
33	250019	Axis Support Bushing	1
34	450032	Cam Clutch Gear	1
35	250012	Large Spring	1
36	450033-BF	Clutch Cover - Black Flat	1
37	GB2760BB16002-SS	Radial Ball Bearing 16002 Sealed	1
38	250016-BF	Clutch Cap - Black Flat	1
39	250011	Circlip Ø15	1
40	250017	Washer Ø6, Locking	1
41	250018	Cross Recessed Pan Head Screw M6 x 16	1
42	451500	Switch Assembly	1
43	300018	Hexagon Head Bolt M8 x 60	2
44	300020	Washer Ø8, Locking	6
45	300019	Washer Ø8, Flat	6
46	300021	Nut M8	2
47	200027-BF	1.25 in. Hitch Adapter - Black Flat	1
48	250037	5/8 in. Hitch Pin	1
49	250038	R Pin	1
50	450021	Hexagon Head Bolt M8 x 25	4
51	250025-BF	Mounting Channel -Black Flat	1
52	400009	Bolt M10x20	2
53	250029-BF	Roller Fairlead - Black Flat	1
54	250035	Lock Washer Ø10	2
55	250036	Lock Nut Ø10	2
56	450500A	Control Switch - Black	1
57	300037-BF	Control Switch Mounting Plate - Black Flat	1
58	400025	Nut M5	2
59	400026-BF	Handlebar Switch Clamp - Black Flat	2
60	400024	Lock Washer Ø5	2
61	400023	Flat Washer Ø5	2
62	400022	Hexagon Socket Head Screw M5 x 25	2

TROUBLESHOOTING

Problem	Cause	Solution
Motor does not turn on	Switch Assembly not connected properly	Insert Switch Assembly all the way into the connector.
	Loose battery cable connections	Tighten nuts on all cable connections.
	Contactors malfunctioning	Tap contactor to loosen contacts. Apply 12 volts to coil terminals directly. A clicking indicates proper activation.
	Defective Switch Assembly	Replace Switch Assembly.
	Defective motor	Check for voltage at armature port with Switch pressed. If voltage is present, Replace motor.
	Water has entered motor	Allow to drain and dry. Run in short bursts without load until completely dry.
Motor runs but Cable drum does not turn	Clutch (Cam Ring) not engaged	Move Cam Ring to the "In" position. If problem persists, a qualified technician needs to check and repair.
Motor runs slowly or without normal power	Insufficient current or voltage	The battery is weak, recharge. Run winch with vehicle motor running (Battery should have a strong charge)
	Loose or corroded battery cable connections.	Clean, Tighten, or replace.
Motor overheating	winch running time too long	Allow winch to cool down periodically.
Motor runs in one direction only	Defective or stuck Contactor	Tap Contactor to loosen contacts.
		Repair or Replace contactor.
	Defective Switch Assembly	Replace Switch Assembly.

For further technical support:

Technical Service

Mon – Fri 8:30 AM – 5:00 PM (PST/PDT)

Toll Free: 1-877-338-0999

tech@championpowerequipment.com

WARRANTY

CHAMPION POWER EQUIPMENT
2 YEAR LIMITED WARRANTY

Warranty Qualifications

To register your product for warranty and FREE lifetime call center technical support please visit:

<https://www.championpowerequipment.com/register>

To complete registration you will need to include a copy of the purchase receipt as proof of original purchase. Proof of purchase is required for warranty service. Please register within ten (10) days from date of purchase.

Repair/Replacement Warranty

CPE warrants to the original purchaser that the mechanical and electrical components will be free of defects in material and workmanship for a period of two years (parts and labor) from the original date of purchase and 180 days (parts and labor) for commercial and industrial use. Transportation charges on product submitted for repair or replacement under this warranty are the sole responsibility of the purchaser. This warranty only applies to the original purchaser and is not transferable.

Do Not Return The Unit To The Place Of Purchase

Contact CPE's Technical Service and CPE will troubleshoot any issue via phone or e-mail. If the problem is not corrected by this method, CPE will, at its option, authorize evaluation, repair or replacement of the defective part or component at a CPE Service Center. CPE will provide you with a case number for warranty service. Please keep it for future reference. Repairs or replacements without prior authorization, or at an unauthorized repair facility, will not be covered by this warranty.

Warranty Exclusions

This warranty does not cover the following repairs and equipment:

Normal Wear

Products with mechanical and electrical components need periodic parts and service to perform well. This warranty does not cover repair when normal use has exhausted the life of a part or the equipment as a whole.

Installation, Use and Maintenance

This warranty will not apply to parts and/or labor if the product is deemed to have been misused, neglected, involved in an accident, abused, loaded beyond the product's limits, modified, installed improperly or connected incorrectly to any electrical component. Normal maintenance is not covered by this warranty and is not required to be performed at a facility or by a person authorized by CPE.

Other Exclusions

This warranty excludes:

- Cosmetic defects such as paint, decals, etc.
- Wear items such as winch cable, etc.
- Accessory parts such as storage covers.
- Failures due to acts of God and other force majeure events beyond the manufacturer's control.
- Problems caused by parts that are not original Champion Power Equipment parts.

Limits of Implied Warranty and Consequential Damage

Champion Power Equipment disclaims any obligation to cover any loss of time, use of this product, freight, or any incidental or consequential claim by anyone from using this product. THIS WARRANTY IS IN LIEU OF ALL OTHER WARRANTIES, EXPRESS OR IMPLIED, INCLUDING WARRANTIES OF MERCHANTABILITY OR FITNESS FOR A PARTICULAR PURPOSE.

A unit provided as an exchange will be subject to the warranty of the original unit. The length of the warranty governing the exchanged unit will remain calculated by reference to the purchase date of the original unit. This warranty gives you certain legal rights which may change from state to state or province to province. Your state or province may also have other rights you may be entitled to that are not listed within this warranty.

Contact Information

Address

Champion Power Equipment, Inc.
Customer Service
12039 Smith Ave.
Santa Fe Springs, CA 90670 USA
www.championpowerequipment.com

Customer Service

Mon – Fri 8:30 AM – 5:00 PM (PST/PDT)
Toll Free: 1-877-338-0999
info@championpowerequipment.com
Fax no.: 1-562-236-9429

Technical Service

Mon – Fri 8:30 AM – 5:00 PM (PST/PDT)
Toll Free: 1-877-338-0999
tech@championpowerequipment.com
24/7 Tech Support: 1-562-204-1188