

CHAMPION

POWER EQUIPMENT™

OWNER'S MANUAL & OPERATING INSTRUCTIONS



10000 lb. SUV/Truck Winch Kit



MODEL NUMBER

11005

SAVE THESE INSTRUCTIONS
Important Safety Instructions
are included in this manual.

MADE IN CHINA
REV 11005-20120511

10006 Santa Fe Springs Road
Santa Fe Springs CA 90670
USA / 1-877-338-0999
www.championpowerequipment.com

Have questions or need assistance?

Do not return this product to the store!

WE ARE HERE TO HELP!

Visit our website:

www.championpowerequipment.com

for more info:

- Product Info & Updates
- Tech Bulletins
- Frequently Asked Questions
- Product Registration

– or –

Call our Customer Care Team Toll-Free at:

1-877-338-0999

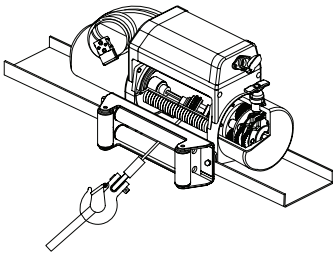

10000 lb. Winch SUV/Truck Winch Kit

TABLE OF CONTENTS

Introduction	1	Specifications	10
Introduction	1	Performance Specifications	10
This Booklet	1	Parts Diagram	11
Accessories	1	Parts List	12
Manual Conventions	2	Troubleshooting	13
Safety Rules	3	Warranty	14
Controls and Features	5	Warranty Qualifications	14
Winch	5	Repair/Replacement Warranty	14
Assembly	6	Do Not Return The Unit To The Place Of Purchase	14
Mounting	6	Warranty Exclusions	14
Mounting the Winch	6	Limits of Implied Warranty And Consequential Damage	14
Operation	7	Contact Information	14
General Tips for Safe Operation	7	Address	14
Self Recovery	7	Customer Service	14
Winching Techniques A-Z	8	Technical Service	14
Maintenance	9		
Lubrication	9		
Cable Assembly Replacement	9		

INTRODUCTION

Introduction

Congratulations on your purchase of a Champion Power Equipment winch. CPE designs and builds winches to strict specifications. With proper use and maintenance, this winch will bring years of satisfying service.

This Booklet

Every effort has been made to ensure the accuracy and completeness of the information in this manual. We reserve the right to change, alter and/or improve the product and this document at any time without prior notice.

Accessories

Champion Power Equipment manufactures and sells accessories designed to help you get the most from your purchase. To find out more about our covers, tree savers, hooks, fairleads, etc., please visit our web site at:

→ www.championpowerequipment.com

Record the model and serial numbers as well as date and place of purchase for future reference. Have this information available when ordering parts and when making technical or warranty inquiries.

Champion Power Equipment Support
1-877-338-0999
Model Number
11005
Serial Number
Date of Purchase
Purchase Location

This manual uses the following symbols to help differentiate between different kinds of information. The safety symbol is used with a key word to alert you to potential hazards in operating and owning power equipment.

Follow all safety messages to avoid or reduce the risk of serious injury or death.

 **DANGER**

DANGER indicates an imminently hazardous situation which, if not avoided, **will** result in death or serious injury.

 **WARNING**

WARNING indicates a potentially hazardous situation which, if not avoided, **could** result in death or serious injury.

 **CAUTION**

CAUTION indicates a potentially hazardous situation which, if not avoided, **may** result in minor or moderate injury.

CAUTION

CAUTION used without the safety alert symbol indicates a potentially hazardous situation which, if not avoided, **may** result in property damage.

 **NOTE**

If you have questions regarding your winch, we can help. Please call our help line at **1-877-338-0999**

SAFETY RULES

WARNING

Read this manual thoroughly before operating your winch. Failure to follow instructions could result in serious injury or death.

WARNING

Do not exceed the rated capacity.

DANGER

Do not use this winch for lifting or moving people or animals.

DANGER

Keep yourself and others a safe distance to the side of the cable when under tension.

DANGER

Never step over a cable or near a cable under load.

WARNING

The wire rope may break before the motor stalls. For heavy loads at or near rated capacity, use a pulley block/snatch block to reduce the load on the wire rope.

WARNING

Do not move the vehicle to pull a load (towing) on the winch cable. This could result in cable breakage.

WARNING

Pull only on areas of the vehicle as specified by the vehicle manufacturer.

WARNING

Do not use the winch to secure or hold a vehicle for a long period of time. Do not use the winch to secure a vehicle for transport.

WARNING

Disconnect the remote control and battery leads when not in use.

WARNING

Avoid “shock loads” by using the control switch intermittently to take up the slack in the wire rope. “Shock loads” can far exceed the rate capacity for the wire rope and drum.

Do not accelerate your vehicle while winching. Loss of traction can cause a shock load on the cable.

WARNING

Batteries contain acid and produce explosive gases.

Keep sparks, flames and cigarettes away from batteries at all times. Wear safety glasses and protect the eyes at all times. Do not lean over the batteries during operation.

⚠ WARNING

When re-spooling the cable, ensure that the cable spools in the under-wind position with the cable entering the drum from the bottom, not the top.

To re-spool correctly, and while wearing gloves, keep a slight load on the cable while pushing the remote button to draw in the cable. Walk toward the winch not allowing the cable to slide through your hands. Do not let your hands get within 12" of the winch while re-spooling. Turn off the winch and repeat the procedure until a few feet of cable are left. Disconnect the remote control and finish spooling by rotating the drum by hand with the clutch disengaged. Keep hands clear of the fairlead and drum while the winch is under power .

⚠ WARNING

Do not use as a hoist. Do not use for overhead lifting.

⚠ CAUTION

Use gloves to protect hands when handling the cable. Never let the cable slide through your hands.

⚠ CAUTION

Do not wrap the cable around any object and hook it back onto itself.

⚠ CAUTION

Apply blocks to the wheels of the vehicle when on an incline.

⚠ CAUTION

Duration of winching pulls should be kept as short as possible.

If the motor becomes uncomfortably hot to the touch, stop winching immediately and let it cool down for a few minutes. Do not pull for more than one minute at or near the rated load.

⚠ CAUTION

If the motor stalls, do not maintain power to the winch.

Electric winches are designed and made for intermittent use and should not be used in constant duty applications.

⚠ CAUTION

Never release the free-spool clutch when there is a load on the winch.

⚠ CAUTION

Use hook strap when handling the hook for spooling or unspooling the wire rope.

CAUTION

DO NOT Mix Old and New batteries
DO NOT Mix Alkaline, Standard, or Rechargeable Batteries

CONTROLS AND FEATURES

Read this owner's manual before operating your winch. Familiarize yourself with the location and function of the controls and features. Save this manual for future reference.

Winch

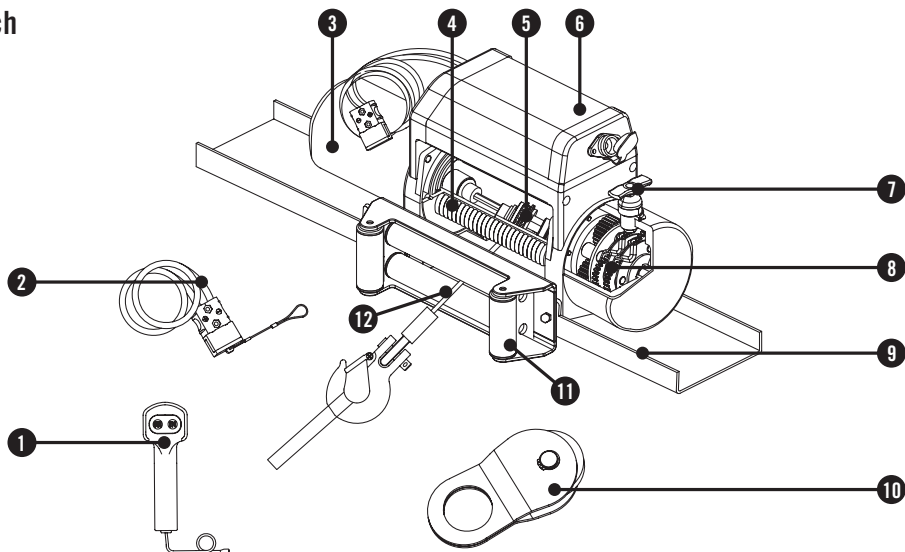

- (1) **Remote Switch** – Dual switches for powering the rope in or out of your winch drum.
- (2) **Quick Connect Leads** – 6 ft. (1.8 m) heavy duty cables with quick connect leads.
- (3) **Motor** – 2.9 Hp 12V DC motor provides power to the planetary gear mechanism.
- (4) **Winch Drum** – The winch drum is the cylinder on which the wire rope is stored. It can feed or wind the rope depending on the remote winch switch.
- (5) **Braking System** – Braking action is automatically applied to the winch drum when the winch motor is stopped and there is a load on the wire rope.
- (6) **Solenoid Assembly** – Power from the vehicle battery flows through the solenoid switch before being directed to the winch motor.
- (7) **Free Spooling Clutch** – The clutch allows the operator to manually disengage “Out” the spooling drum from the gear train, free spool. Engaging the clutch “In” locks the winch into the gear system.
- (8) **Planetary Gear System** – The reduction gears convert the winch motor power into extreme pulling forces. This system allows high torque while maintaining compact size and light weight.
- (9) **Mounting Channel** – A flat bed mounting channel that can be mounted to most flat surfaces such as trailers, step bumpers, truck beds, etc. The mounting channel also has holes to accept your roller fairlead (11).
- (10) **Snatch Block** – Used properly, the snatch block can double the pulling power of the winch, or change your pulling directly without damaging the wire rope.
- (11) **Roller Fairlead** – When using the winch at an angle the roller fairlead acts to guide the wire rope onto the drum and minimizes damage to the wire rope from abrasion on the winch mount or bumper.
- (12) **Wire Rope** – 3/8 in. x 85 ft. (9.2 mm x 25.9 m) galvanized aircraft cable designed specifically for load capacity of 10000 lb. (4536 kg.)

Mounting

This CPE 10,000 lb winch is designed with a 10" x 4.5" bolt pattern that is standard in this class of winch. Many winch mounting kits are available that utilize this bolt pattern for the most popular trucks, SUV's. If you cannot find a kit locally, contact CPE and we will provide you with the name of a dealer near you.

If you will utilize the CPE mounting channel you must ensure that it is mounted on a flat surface so that the three major sections (motor, drum and gear housing) are properly aligned. Proper alignment of the winch will allow even distribution of the full rated load.

Mounting the Winch

1. Insert 2 x M10x35 bolts in the mounting channel hole and attach the Roller Fairlead to the mounting channel with the 2 flat washers, lock washers and M10 nuts provided.
2. Turn the winch up-side-down; insert 4xM10 nuts into the holes on each leg of the winch.
3. Place the Mounting Channel on the winch, making sure the winch is centered in the middle of the mounting channel. Disengage the clutch by rotating the clutch knob to the "Out" position. Release the wire rope and pull through the slot in the front of the channel.
4. Secure the mounting channel to the winch using the 4xM10 Cap Screws with the 4 flat washers and lock washers.
5. Attach the clevis hook and hand strap.
6. Connect the battery leads:
 - Connect the red lead to the positive (+) terminal of the vehicle's 12 volt battery.
 - Connect the black lead to the negative (-) terminal of the vehicle's 12 volt battery.
 - Place all terminal boots over terminals and secure all cables with cable ties or electrical tape (not included).

Mounting the Winch cont'd.

7. Attach the hand held remote lead to the winch and test for proper operation.
8. Check for proper drum rotation. Pull and turn the clutch knob to the "OUT" position (free spooling). Pull out some cable from the drum, and then turn the clutch knob to the "IN" position to engage the gears. Press the cable out button on the rocker switch. If the drum is turning and releasing more cable, then your connections are accurate. If the drum is turning and collecting more cable then reverse the leads on the motor. Repeat and check rotation.

! CAUTION

Mounting bolts must be SAE grade 5 or better and torque to 34 ft. lbs.

! CAUTION

NEVER route electrical cables across any sharp edges, through and/or near moving parts, or near parts that may become hot.

! CAUTION

Battery cables should **NOT** be drawn taut. Leave some slack for cable movement.

NOTE

You may need to use a test light to locate a suitable wire. The wire should only have power when the key is in the ON position.

OPERATION

General Tips for Safe Operation

Your 11005 winch is rated at a 10000 lb. (4536 kg.) capacity in first layer (max) when spooling the first rope layer on the drum. Overloads can damage the winch, motor and/or wire rope. For loads over

5,000 lbs. (2268 kg.) we recommend the use of the pulley block/snatch block to double the wire rope line. This will aid in two ways:

- reduce the number of rope layers on the drum, as well as,
- reduce the load on the wire rope by as much as 50%.

When doubling the line back to the vehicle, attach to the tow hook, frame or other load bearing part. The vehicle engine should be kept running during operation of the winch to minimize battery drain and maximize power and speed of the winch. If the winch is used for a considerable time with the engine off the battery may be drained and too weak to restart the engine.

Get to know your winch before you actually need to use it. We recommend that you set up a few test runs to familiarize yourself with rigging techniques, the sounds your winch makes under various loads, the way the cable spools on the drum, etc.

Inspect the wire rope and equipment before each use. A frayed or damaged rope shall be replaced immediately. Use only manufacturer's identical replacement rope with the exact specifications.

Inspect the winch installation and bolts to ensure that all bolts are tight before each operation. Store the remote control inside your vehicle in a place that it will not be damaged.

Any winch that appears to be damaged in any way, is found to be worn, or operates abnormally **MUST BE REMOVED FROM SERVICE UNTIL REPAIRED**. It is recommended that the necessary repairs be made by a manufacturer's authorized repair facility.

Pull only on areas of the vehicle as specified by the vehicle manufacturer. Only attachments and/or adapters supplied by the manufacturer are to be used.

Self Recovery

Locate a suitable anchor such as a strong tree trunk or boulder. Always use a sling as an anchor point.

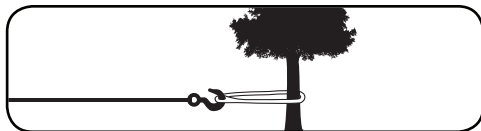

A roller fairlead (not included) will help guide the wire rope and to reduce binding on short side pulls. Do not winch from an acute angle as the wire rope will pile up on one side of the drum causing damage to wire rope and the winch.

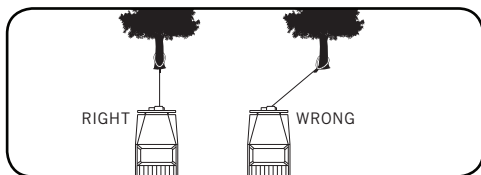

Short pulls from an angle can be used to straighten the vehicle. Long pulls should be done with the wire rope at a 90° angle to the winch/vehicle.

When pulling any load, place a blanket or jacket over the wire rope five or six feet from the hook.

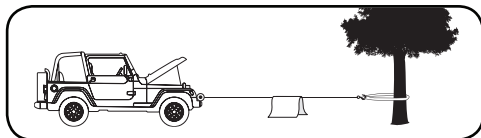

In the event of a broken cable it will dampen the snap back. For additional protection open the hood of the vehicle. For pulls over 5,000 lbs. (2268 kg.), we recommend the use of the snatch block/pulley block to double line the wire rope.

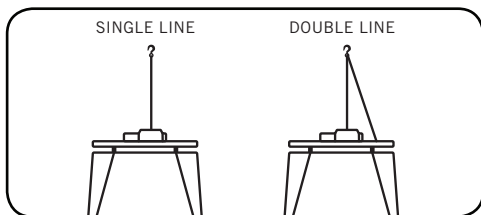

This reduces the load on the winch and the strain on the rope by approximately 50%.

Winching Techniques A-Z

- (a) Take time to assess your situation and plan your pull.
- (b) Put on gloves to protect your hands.
- (c) Disengage the clutch to allow free- spooling and also save battery power.
- (d) Attach the hook strap to the clevis hook.
- (e) Pull out the wire rope to your desired anchor point using the hook strap.
- (f) Secure the clevis hook to the anchor point: Sling, chain or snatch block. Do not attach the hook back onto the wire rope.
- (g) Engage the clutch.
- (h) Connect the remote control to the winch. If you are going to control the winch from inside your vehicle then pass the remote through an open window to avoid the wires being pinched in the door.
- (i) Start your engine to ensure power is being replenished to the battery.
- (j) Drape a blanket or jacket over the wire rope approximately 5 to 6 feet from the hook. Open the hood for added protection.
- (k) Power in the wire rope guiding the wire under tension to draw up the slack in the wire. Once the wire is under tension, stand clear. Never step over the wire rope.
- (l) Double check your anchors and make sure all connections are secure.
- (m) Inspect the wire rope. Make sure there are at least 5 wraps of wire rope around the winch drum.
- (n) Clear the area. Make sure all spectators stand clear and that no one is directly in front or behind the vehicle or anchor point.
- (o) Begin winching. Be sure that the wire rope is winding evenly and tightly around the drum. The vehicle that is being winched can be slowly driven to add assistance to the winching process. Avoid shock loads; keep the wire rope under tension.

Winching Techniques A-Z Cont'd.

- (p) The vehicle to be winched should be placed in neutral and the emergency brake released. Only release the brake pedal when under full tension. Avoid shock loads to the winch. This can damage the winch, rope and vehicle.
- (q) The winch is meant for intermittent use. Under full load with a single line rig do not power in for more than a minute without letting the motor cool down for a few minutes and then resume the winching operation.
- (r) The winching operation is complete once the vehicle is on stable ground and is able to drive under its own power.
- (s) Secure the vehicle. Be sure to set the brakes and place the vehicle in park.
- (t) Release the tension on the wire rope. The winch is not meant to hold the vehicle for long periods of time.
- (u) Disconnect the wire rope from the anchor.
- (v) Rewind the wire rope. Make sure that any wire already on the drum has spooled tightly and neatly. If not, draw out the wire and re-spool from the point where the rope is tight.
- (w) Keep your hands clear of the winch drum and fairlead as the wire rope is being drawn in.
- (x) Secure the hook and hook strap.
- (y) Disconnect the remote control and store in a clean, dry place.
- (z) Clean and inspect connections and mounting hardware for next winching operation.

MAINTENANCE

The owner/operator is responsible for all periodic maintenance.

WARNING

Never operate a damaged or defective winch.

WARNING

Improper maintenance will void your warranty.

Complete all scheduled maintenance in a timely manner. Correct any issue before operating the winch.

NOTE

For service or parts assistance, contact our help line at **1-877-338-0999**

Lubrication

All moving parts within the Electric Winch having been Lubricated using high temperature lithium grease at the factory. No internal lubrication is required. Lubricate Cable Assembly periodically using a light penetrating oil.

Cable Assembly Replacement

It is recommended that any modifications be performed by a manufacturer's authorized repair facility, and that only manufacturer-supplied parts be used.

1. Move the clutch to the "Out" position.
2. Extend Cable Assembly to its full length.
Note how the existing cable is connected to the inside of the drum.
3. Remove old Cable Assembly and attach new one.
4. Retract Cable Assembly onto drum being careful not to allow kinking.

Performance Specifications

- Rated Pull 10000 lb. (4536 kg.)
- Gear Reduction Ratio 216:1
- Motor Series Wound
Output 2.9HP/2.2KW(DC12V)
Input 6.7HP/5.0KW(DC12V)
- Duty cycle Intermittent use only
- Drum Size 2.48 in. (D) x 8.84 in. (L) [63 mm (D) x 224.5 mm (L)]
- Cable 3/8 in. (D) x 85' (L) [9.2 mm (D) x 25.9 m (L)]
- Gross Weight 122.4 lbs (55.5 kg)
- Net Weight 115.7 lbs (52.5 kg)
- Height 10.52 in. (26.7 cm)
- Width 5.82 in. (14.8 cm)
- Length 21.77 in. (55.3 cm)
- Bolt Pattern 10 in. x 4.5 in. (25.4 cm x 11.43 cm)

Line Speed and Motor Current (First Layer)							
Line Pull	LB	0	2000	4000	6000	8000	10000
	KG	0	907	1814	2722	3629	4536
Line Speed (12V DC)	FPM	15.7	9.8	7.2	5.9	4.9	3.9
	MPM	4.8	3.0	2.2	1.8	1.5	1.2
Motor Current (12V DC)	A	115	175	220	280	320	400
Running Time*	Minutes	1	1	1	1	1	1
Cooling Time**	Minutes	5	5	5	5	5	5

*If the motor becomes uncomfortably hot to the touch, stop winching immediately and let it cool down for 5 minutes. Do not pull for more than one minute at or near the rated load.

**Electric winches are designed and made for intermittent use and should not be used in constant duty applications.

Line Pull and Cable Capacity Per Layer					
Line of Cable		1	2	3	4
Rated Line Pull	LB	10000	8000	6600	5600
	KG	4536	3629	2994	2540
Cable Capacity	FT	18	39.4	64	85
	M	5.5	12.0	19.5	25.9

SPECIFICATIONS

Parts Diagram

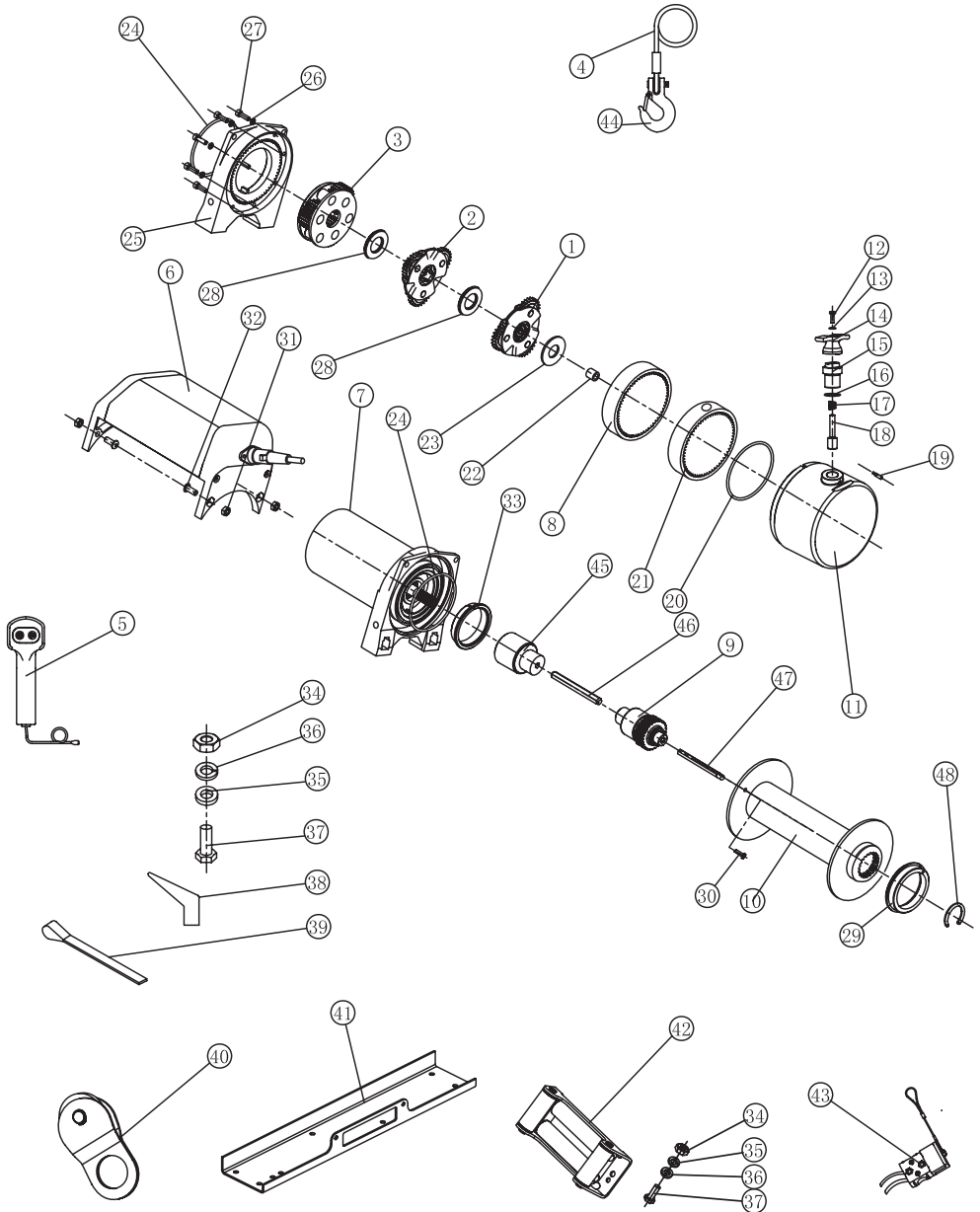

#	Part Number	Description	Qty
1	P1010100	Gear Carrier Assembly -Input	1
2	P1010200	Gear Carrier Assembly -Intermediate	1
3	P1010300-N	Gear Carrier Assembly-Output	1
4	P1010400	Cable Assembly	1
5	P1011001-B	Switch Assembly - B	1
6	P1011002-2-BF	Up-setting Solenoid Assembly - Black Flat	1
7	P1011004-BF	Motor/End Bearing Assembly - Black Flat	1
8	P1011021	Gear Housing A	1
9	810600-NA	Brake Assembly	1
10	P1010900-N-BA	Drum Assembly	1
11	P1011005-N-BF	Gear Housing End Cover -Black Flat	1
12	P1011022	Pan Head Screw M5x15	1
13	P1011023	Washer 5	1
14	P1011024	Clutch Handle	1
15	P1011025	Clutch Seat	1
16	P1011026	Seal Ring 20x1.8	1
17	P1011027	Spring	1
18	P1011028	Clutch Pin	1
19	P1011029	Set Screw M4x8	1
20	P1011010	Gear Housing End Cover Seal	1
21	P1011030	Gear Housing B	1
22	P1011012	Bushing	1

#	Part Number	Description	Qty
23	P1011013	Thrust Washer	1
24	P1011014	Motor/End Bearing Seal	2
25	P1011032-BF	End Bearing - Black Flat	1
26	P1011016	Lock Washer 6	8
27	P1011017	Cap Screw M6x20	8
28	P1011018	Thrust Disc	2
29	P1010008	Bushing -Drum	1
30	P1010012	Cap Screw M6x10	1
31	P1010013	Lock Nut M8	4
32	P1010014	Hex Head Screw M8x22	4
33	P1010015	Motor/Drum Bushing	1
34	810024	Lock Nut M10	6
35	810023	Flat Washer 10	6
36	810022	Lock Washer 10	6
37	810021	Cap Screw M10x35	6
38	810025-N	Terminal Protector	3
39	300900	Strap	1
40	P1011100-BF	Snatch Block - Black Flat	1
41	810028-BF	Mounting Channel - Black Flat	1
42	811000-BF	Roller Fairlead - Black Flat	1
43	P1011019	6ft Battery Lead with Quick Connect	1
44	C10038	Clevis Hook 3/8"	1
45	810033	Motor Coupling	1
46	P1011033	Hexagonal Shaft I	1
47	P1011034	Hexagonal Shaft II	1
48	810035	Retainer-Ring 50	1

TROUBLESHOOTING

Problem	Cause	Solution
Motor does not turn on	Switch Assembly not connected properly	Insert Switch Assembly all the way into the connector.
	Loose battery cable connections	Tighten nuts on all cable connections.
	Contactors malfunctioning	Tap contactor to loosen contacts. Apply 12 volts to coil terminals directly. A clicking indicates proper activation.
	Defective Switch Assembly	Replace Switch Assembly.
	Defective motor	Check for voltage at armature port with Switch pressed. If voltage is present, Replace motor.
	Water has entered motor	Allow to drain and dry. Run in short bursts without load until completely dry.
Motor runs but Cable drum does not turn	Clutch (Cam Ring) not engaged	Move Cam Ring to the "In" position. If problem persists, a qualified technician needs to check and repair.
Motor runs slowly or without normal power	Insufficient current or voltage	The battery is weak, recharge. Run winch with vehicle motor running (Battery should have a strong charge)
	Loose or corroded battery cable connections.	Clean, Tighten, or replace.
Motor overheating	winch running time too long	Allow winch to cool down periodically.
Motor runs in one direction only	Defective or stuck Contactor	Tap Contactor to loosen contacts.
		Repair or Replace contactor.
	Defective Switch Assembly	Replace Switch Assembly.

For further technical support:

Technical Service

Mon – Fri 8:30 AM – 5:00 PM (PST/PDT)

Toll Free: 1-877-338-0999

tech@championpowerequipment.com

WARRANTY

CHAMPION POWER EQUIPMENT 2 YEAR LIMITED WARRANTY

Effective September 1, 2006. Replaces all undated warranties and all warranties dated before September 1, 2006.

Warranty Qualifications

Champion Power Equipment (CPE) will register this warranty upon receipt of your Warranty Registration Card and a copy of your sales receipt from one of CPE's retail locations as proof of purchase.

Please submit your warranty registration and your proof of purchase within ten (10) days of the date of purchase.

Repair/Replacement Warranty

CPE warrants to the original purchaser that the mechanical and electrical components will be free of defects in material and workmanship for a period of one year (parts and labor) and two years (parts) from the original date of purchase (90 days (parts and labor) and 180 days (parts) for commercial & industrial use). Transportation charges on product submitted for repair or replacement under this warranty are the sole responsibility of the purchaser. This warranty only applies to the original purchaser and is not transferable.

Do Not Return The Unit To The Place Of Purchase

Contact CPE's Technical Service and CPE will troubleshoot any issue via phone or e-mail. If the problem is not corrected by this method, CPE will, at its option, authorize evaluation, repair or replacement of the defective part or component at a CPE Service Center. CPE will provide you with a case number for warranty service. Please keep it for future reference. Repairs or replacements without prior authorization, or at an unauthorized repair facility, will not be covered by this warranty.

Warranty Exclusions

This warranty does not cover the following repairs and equipment:

Normal Wear

Winches need periodic parts and service to perform well. This warranty does not cover repair when normal use has exhausted the life of a part or the equipment as a whole.

Installation, Use and Maintenance

This warranty will not apply to parts and/or labor if this winch is deemed to have been misused, neglected, involved in an accident, abused, loaded beyond the winch's limits, modified, installed improperly or connected incorrectly to any electrical component. Normal maintenance is not covered by this warranty.

Other Exclusions

This warranty excludes: The winch cable. Cosmetic defects such as paint, decals, etc. Accessory parts such as storage covers. Failures due to acts of God and other force majeure events beyond the manufacturer's control. Problems cause by parts that are not original Champion Power Equipment parts.

Limits of Implied Warranty and Consequential Damage

Champion Power Equipment disclaims any obligation to cover any loss of time, use of this product, freight, or any incidental or consequential claim by anyone from using this winch. THIS WARRANTY IS IN LIEU OF ALL OTHER WARRANTIES, EXPRESS OR IMPLIED, INCLUDING WARRANTIES OF MERCHANTABILITY OR FITNESS FOR A PARTICULAR PURPOSE

A unit provided as an exchange will be subject to the warranty of the original unit. The length of the warranty governing the exchanged unit will remain calculated by reference to the purchase date of the original unit. This warranty gives you certain legal rights which may change from state to state. Your state may also have other rights you may be entitled to that are not listed within this warranty.

Contact Information

Address

Champion Power Equipment, Inc.
Customer Service
10006 Santa Fe Springs Rd.
Santa Fe Springs, CA 90670
www.championpowerequipment.com

Customer Service

Mon – Fri 8:30 AM – 5:00 PM (PST/PDT)
Toll Free: 1-877-338-0999
Fax no.: 1 (562) 236-9429

Technical Service

Mon – Fri 8:30 AM – 5:00 PM (PST/PDT)
Toll Free: 1-877-338-0999
tech@championpowerequipment.com