

CHAMPION

POWER EQUIPMENT™

OWNER'S MANUAL & OPERATING INSTRUCTIONS

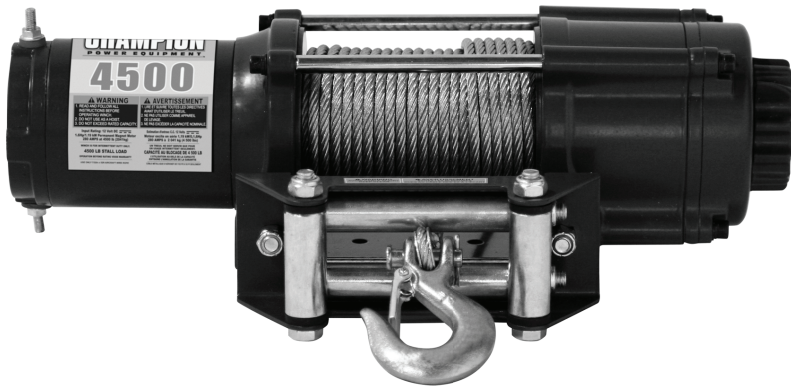

4500 lb. WINCH

2YEAR
LIMITED WARRANTY

MODEL NUMBER
14552

SAVE THESE INSTRUCTIONS
Important Safety Instructions
are included in this manual.

MADE IN CHINA
REV 14552-20100927

10006 Santa Fe Springs Road
Santa Fe Springs CA 90670
USA / 1 (877) 338-0999
www.championpowerequipment.com

Have questions or need assistance?

Do not return this product to the store!

WE ARE HERE TO HELP!

Visit our website:

www.championpowerequipment.com

for more info:

- Product Info & Updates
- Tech Bulletins
- Frequently Asked Questions
- Product Registration

– or –

Call our Customer Care Team Toll-Free at:

1-877-338-0999

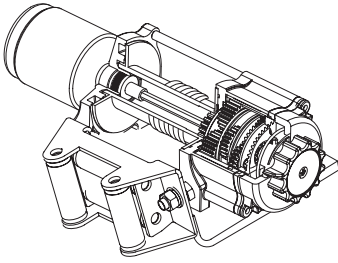

4500 lb. WINCH

TABLE OF CONTENTS

Introduction	1	Specifications	10
Introduction	1	Performance Specifications	10
This Booklet	1	Parts Diagram	11
Accessories	1	Parts List	12
Manual Conventions	2	Troubleshooting	13
Safety Rules	3	Warranty	14
Controls and Features	5	Warranty Qualifications	14
Winch	5	Repair/Replacement Warranty	14
Assembly	6	Do Not Return The Unit To The Place Of Purchase	14
Mounting the Winch	6	Warranty Exclusions	14
Operation	7	Limits of Implied Warranty And Consequential Damage	14
General Tips for Safe Operation	7	Contact Information	14
Self Recovery	7	Address	14
Winching Techniques A-Z	8	Customer Service	14
Maintenance	9	Technical Service	14
Lubrication	9		
Cable Assembly Replacement	9		

INTRODUCTION

Introduction

Congratulations on your purchase of a Champion Power Equipment winch. CPE designs and builds winches to strict specifications. With proper use and maintenance, this winch will bring years of satisfying service.

This Booklet

Every effort has been made to ensure the accuracy and completeness of the information in this manual. We reserve the right to change, alter and/or improve the product and this document at any time without prior notice.

Accessories

Champion Power Equipment manufactures and sells accessories designed to help you get the most from your purchase. To find out more about our covers, tree savers, hooks, fairleads, etc., please visit our web site at:

→ www.championpowerequipment.com

Record the model and serial numbers as well as date and place of purchase for future reference. Have this information available when ordering parts and when making technical or warranty inquiries.

Champion Power Equipment Support
1 (877) 338-0999
Model Number
14552
Serial Number
Date of Purchase
Purchase Location

This manual uses the following symbols to help differentiate between different kinds of information. The safety symbol is used with a key word to alert you to potential hazards in operating and owning power equipment.

Follow all safety messages to avoid or reduce the risk of serious injury or death.

 **DANGER**

DANGER indicates an imminently hazardous situation which, if not avoided, **will** result in death or serious injury.

 **WARNING**

WARNING indicates a potentially hazardous situation which, if not avoided, **could** result in death or serious injury.

 **CAUTION**

CAUTION indicates a potentially hazardous situation which, if not avoided, **may** result in minor or moderate injury.

CAUTION

CAUTION used without the safety alert symbol indicates a potentially hazardous situation which, if not avoided, **may** result in property damage.

 **NOTE**

If you have questions regarding your winch, we can help. Please call our help line at **1 (877) 338-0999**

SAFETY RULES

WARNING

Read this manual thoroughly before operating your winch. Failure to follow instructions could result in serious injury or death.

WARNING

Do not exceed the rated capacity.

DANGER

Do not use this winch for lifting or moving people or animals.

DANGER

Keep yourself and others a safe distance to the side of the cable when under tension.

DANGER

Never step over a cable or near a cable under load.

WARNING

The wire rope may break before the motor stalls. For heavy loads at or near rated capacity, use a pulley block/snatch block to reduce the load on the wire rope.

WARNING

Do not move the vehicle to pull a load (towing) on the winch cable. This could result in cable breakage.

WARNING

Pull only on areas of the vehicle as specified by the vehicle manufacturer.

WARNING

Do not use the winch to secure or hold a vehicle for a long period of time. Do not use the winch to secure a vehicle for transport.

WARNING

Disconnect the remote control and battery leads when not in use.

WARNING

Avoid "shock loads" by using the control switch intermittently to take up the slack in the wire rope. "Shock loads" can far exceed the rate capacity for the wire rope and drum.

Do not accelerate your vehicle while winching. Loss of traction can cause a shock load on the cable.

WARNING

Batteries contain acid and produce explosive gases.

Keep sparks, flames and cigarettes away from batteries at all times. Wear safety glasses and protect the eyes at all times. Do not lean over the batteries during operation.

⚠ WARNING

When re-spooling the cable, ensure that the cable spools in the under-wind position with the cable entering the drum from the bottom, not the top.

To re-spool correctly, and while wearing gloves, keep a slight load on the cable while pushing the remote button to draw in the cable. Walk toward the winch not allowing the cable to slide through your hands. Do not let your hands get within 12" of the winch while re-spooling. Turn off the winch and repeat the procedure until a few feet of cable are left. Disconnect the remote control and finish spooling by rotating the drum by hand with the clutch disengaged. Keep hands clear of the fairlead and drum while the winch is under power .

⚠ WARNING

Do not use as a hoist. Do not use for overhead lifting.

⚠ CAUTION

Use gloves to protect hands when handling the cable. Never let the cable slide through your hands.

⚠ CAUTION

Do not wrap the cable around any object and hook it back onto itself.

⚠ CAUTION

Apply blocks to the wheels of the vehicle when on an incline.

⚠ CAUTION

Duration of winching pulls should be kept as short as possible.

If the motor becomes uncomfortably hot to the touch, stop winching immediately and let it cool down for a few minutes. Do not pull for more than one minute at or near the rated load.

⚠ CAUTION

If the motor stalls, do not maintain power to the winch.

Electric winches are designed and made for intermittent use and should not be used in constant duty applications.

⚠ CAUTION

Never release the free-spool clutch when there is a load on the winch.

⚠ CAUTION

Use hook strap when handling the hook for spooling or unspooling the wire rope.

CONTROLS AND FEATURES

Read this owner's manual before operating your winch. Familiarize yourself with the location and function of the controls and features. Save this manual for future reference.

Winch

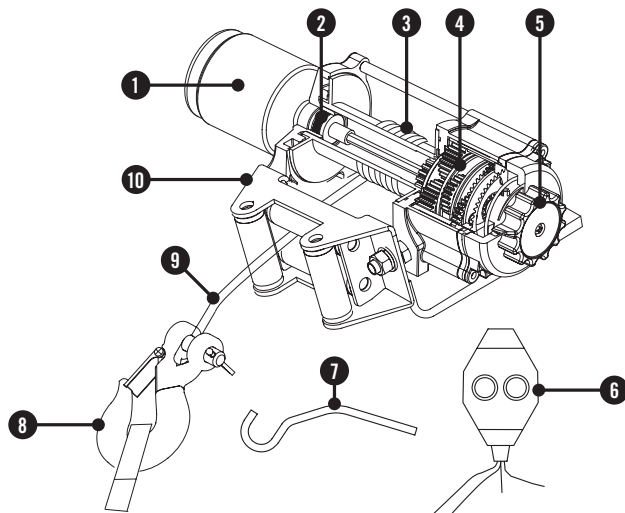

- (1) **Motor** – 1.6 HP 12V DC motor provides power to the planetary gear mechanism.
- (2) **Braking System** – Braking action is automatically applied to the winch drum when the winch motor is stopped and there is a load on the wire rope.
- (3) **Winch Drum** – The winch drum is the cylinder on which the wire rope is stored. It can feed or wind the rope depending on the remote winch switch.
- (4) **Planetary Gear System** – The reduction gears convert the winch motor power into extreme pulling forces. This system allows high torque while maintaining compact size and light weight.
- (5) **Free spooling Clutch** – The clutch allows the operator to manually disengage “Out” the spooling drum from the gear train, free spool. Engaging the clutch “In” locks the winch into the gear system.
- (6) **Remote Switch** – Mountable remote control for powering the rope in or out of your winch drum.
- (7) **Hand Saver bar** – Used for guiding cable.
- (8) **Clevis Hook** – Provides a means for connecting the looped ends of cables to an anchor.
- (9) **Wire Rope** – $\frac{1}{4}$ " x 52' galvanized aircraft cable designed specifically for load capacity of 4,500 lb.
- (10) **Roller Fairlead** – When using the winch at an angle the roller fairlead acts to guide the wire rope onto the drum and minimizes damage to the wire rope from abrasion on the winch mount or bumper.

Mounting the Winch

This CPE 4,500 lb winch is designed with a bolt pattern that is standard in this class of winch. Many winch mounting kits are available that utilize this bolt pattern for the most popular trucks, SUV's and ATV's. If you cannot find a kit locally, contact CPE and we will provide you with the name of a dealer.

⚠ CAUTION

Mounting bolts must be SAE grade 5 or better and torque to 34 ft. lbs.

1. Insert 2 M10 bolts to the mounting channel hole and attach the Roller Fairlead to the mounting channel with the Nut M10 provided. (see page 11 for diagram)
2. Insert M8 bolt through M8 lock washer, M8 flat washer, and mounting channel to attach each winch leg. Repeat for all four legs.
3. Disengage the clutch by rotating the clutch knob to the "Out" position. Release the wire rope and pull through the roller fairlead.
4. Attach the clevis hook and hand strap.
5. Connect the battery leads. FOR WINCH TO FUNCTION PROPERLY: Connect the red (+) lead of the remote to the red (+) terminal of the vehicle's 12 volt battery. Connect the black (-) lead of the remote to the black (-) terminal of the vehicle's 12 volt battery.

Mounting the Winch Cont'd.

6. Attach the remote lead to the winch and test for proper operation. Check for proper drum rotation. Pull and turn the clutch knob to the "out" position (Free spooling). Pull out some cable from the drum, and then turn the clutch knob to the "In" position to engage the gears. Press the cable out button on the switch. If the drum is turning and releasing more cable then your connections are accurate. If the drum is turning and collecting more cable then reverse the leads on the motor. Repeat and check rotation.

⚠ CAUTION

Battery cables should not be drawn taut. Leave some slack for cable movement.

OPERATION

General Tips for Safe Operation

Your 14552 winch is rated at a 4,500 lb. capacity in first layer (max) when spooling the first rope layer on the drum. Overloads can damage the winch, motor and/or wire rope. For loads over 2,250 lbs. we recommend the use of the pulley block/snatch block to double the wire rope line.

This will aid in two ways:

- reduce the number or rope layers on the drum, as well as,
- reduce the load on the wire rope by as much as 50%.

When doubling the line back to the vehicle, attach to the tow hook, frame or other load bearing part. The vehicle engine should be kept running during operation of the winch to minimize battery drain and maximize power and speed of the winch. If the winch is used for a considerable time with the engine off the battery may be drained and too weak to restart the motor.

Get to know your winch before you actually need to use it. We recommend that you set up a few test runs to familiarize yourself with rigging techniques, the sounds your winch makes under various loads, the way the cable spools on the drum, etc.

Inspect the wire rope and equipment before each use. A frayed or damaged rope shall be replaced immediately. Use only manufacturer's identical replacement rope with the exact specifications.

Inspect the winch installation and bolts to ensure that all bolts are tight before each operation. Store the remote control inside your vehicle in a place that it will not be damaged.

Any winch that appears to be damaged in any way, is found to be worn, or operates abnormally **MUST BE REMOVED FROM SERVICE UNTIL REPAIRED**. It is recommended that the necessary repairs be made by a manufacturer's authorized repair facility.

Pull only on areas of the vehicle as specified by the vehicle manufacturer. Only attachments and/or adapters supplied by the manufacturer are to be used.

Self Recovery

Locate a suitable anchor such as a strong tree trunk or boulder. Always use a sling as an anchor point.

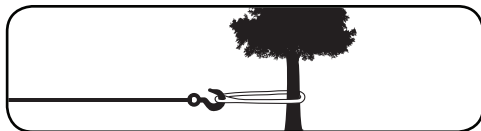

Your winch is equipped with a roller fairlead to help guide the wire rope and to reduce binding on short side pulls. Do not winch from an acute angle as the wire rope will pile up on one side of the drum causing damage to wire rope and the winch.

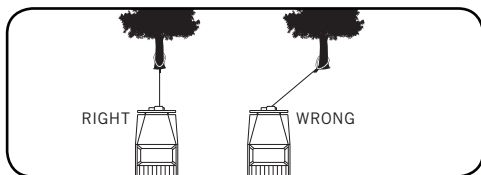

Short pulls from an angle can be used to straighten the vehicle. Long pulls should be done with the wire rope at a 90° angle to the winch/vehicle.

When pulling a heavy load, place a blanket or jacket over the wire rope five or six feet from the hook.

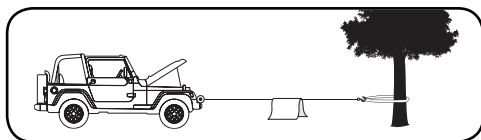

In the event of a broken cable it will dampen the snap back. For additional protection open the hood of the vehicle. For pulls over 2,250 lbs., we recommend the use of the snatch block/pulley block to double line the wire rope.

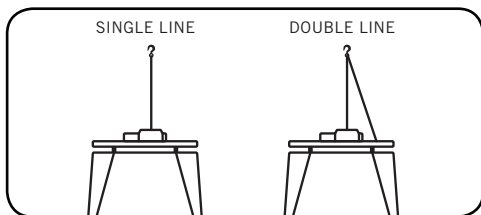

This reduces the load on the winch and the strain on the rope by approximately 50%.

Winching Techniques A-Z

- (a) Take time to assess your situation and plan your pull.
- (b) Put on gloves to protect your hands.
- (c) Disengage the clutch to allow free- spooling and also save battery power.
- (d) Attach the hook strap to the clevis hook.
- (e) Pull out the wire rope to your desired anchor point using the hook strap.
- (f) Secure the clevis hook to the anchor point: Sling, chain or snatch block. Do not attach the hook back onto the wire rope.
- (g) Engage the clutch.
- (h) Connect the remote control to the winch. If you are going to control the winch from inside your vehicle then pass the remote through an open window to avoid the wires being pinched in the door.
- (i) Start your engine to ensure power is being replenished to the battery.
- (j) Power in the wire rope guiding the wire under tension to draw up the slack in the wire. Once the wire is under tension, stand clear. Never step over the wire rope.
- (k) Double check your anchors and make sure all connections are secure.
- (l) Inspect the wire rope. Make sure there are at least 5 wraps of wire rope around the winch drum.
- (m) Drape a blanket or jacket over the wire rope approximately 5 to 6 feet from the hook. Open the hood for added protection.
- (n) Clear the area. Make sure all spectators stand clear and that no one is directly in front or behind the vehicle or anchor point.
- (o) Begin winching. Be sure that the wire rope is winding evenly and tightly around the drum. The vehicle that is being winched can be slowly driven to add assistance to the winching process. Avoid shock loads; keep the wire rope under tension.

Winching Techniques A-Z Cont'd.

- (p) The vehicle to be winched should be placed in neutral and the emergency brake released. Only release the brake pedal when under full tension. Avoid shock loads to the winch. This can damage the winch, rope and vehicle.
- (q) The winch is meant for intermittent use. Under full load with a single line rig do not power in for more than a minute without letting the motor cool down for a few minutes and then resume the winching operation.
- (r) The winching operation is complete once the vehicle is on stable ground and is able to drive under its own power.
- (s) Secure the vehicle. Be sure to set the brakes and place the vehicle in park.
- (t) Release the tension on the wire rope. The winch is not meant to hold the vehicle for long periods of time.
- (u) Disconnect the wire rope from the anchor.
- (v) Rewind the wire rope. Make sure that any wire already on the drum has spooled tightly and neatly. If not, draw out the wire and re-spool from the point where the rope is tight.
- (w) Keep your hands clear of the winch drum and fairlead as the wire rope is being drawn in.
- (x) Secure the hook and hook strap.
- (y) Disconnect the remote control and store in a clean, dry place.
- (z) Clean and inspect connections and mounting hardware for next winching operation.

MAINTENANCE

The owner/operator is responsible for all periodic maintenance.

WARNING

Never operate a damaged or defective winch.

WARNING

Improper maintenance will void your warranty.

Complete all scheduled maintenance in a timely manner. Correct any issue before operating the winch.

NOTE

For service or parts assistance, contact our help line at **1 (877) 338-0999**

Lubrication

All moving parts within the Electric Winch having been Lubricated using high temperature lithium grease at the factory. No internal lubrication is required. Lubricate Cable Assembly periodically using a light penetrating oil.

Cable Assembly Replacement

It is recommended that any modifications be performed by a manufacturer's authorized repair facility, and that only manufacturer-supplied parts be used.

1. Move the clutch to the "Out" position.
2. Extend Cable Assembly to its full length.
Note how the existing cable is connected vto the inside of the drum.
3. Remove old Cable Assembly and attach new one.
4. Retract Cable Assembly onto drum being careful not to allow kinking.

Performance Specifications

- Rated Pull 4,500 lbs (2041 kg)
- Gear Reduction Ratio 166:1
- Motor Permanent Magnet 1.6HP/1.19kW (12V DC)
- Duty Cycle Intermittent
- Duty Cycle Drum Size 2" (D) x 4.92" (L) [50.8 mm (D) x 125 mm (L)]
- Cable ¼" (D) x 52' (L) [6 mm (D) x 16 m (L)]
- Weight G.W. 34.9 lbs. (15.8 kg)
N.W. 32 lbs. (14.5 kg)
- Height 5 inches (127 mm)
- Width 4.55 inches (115.5 mm)
- Length 16.3 inches (415 mm)
- Bolt Pattern 6.6" x 3" (168 mm x 76 mm)

Line Speed and Motor Current (First Layer)						
Line Pull	LB	0	1000	2000	3000	4500
	KG	0	454	907	1361	2041
Line Speed (12V DC)	FPM	12.8	9.8	8.5	6.9	3.9
	MPM	3.9	3.0	2.6	2.1	1.2
Motor Current (12V DC)	A	28	80	130	180	280
Running Time*	Minutes	1	1	1	1	1
Cooling Time**	Minutes	5	5	5	5	5

*If the motor becomes uncomfortably hot to the touch, stop winching immediately and let it cool down for 5 minutes. Do not pull for more than one minute at or near the rated load.

**Electric winches are designed and made for intermittent use and should not be used in constant duty applications.

Line Pull and Cable Capacity Per Layer					
Line of Cable		1	2	3	4
Rated Line Pull	LB	4500	3841	3310	2907
	KG	2041	1742	1501	1319
Cable Capacity	FT	13.4	28.8	45.8	52
	M	4.1	8.8	14	16

SPECIFICATIONS

Parts Diagram

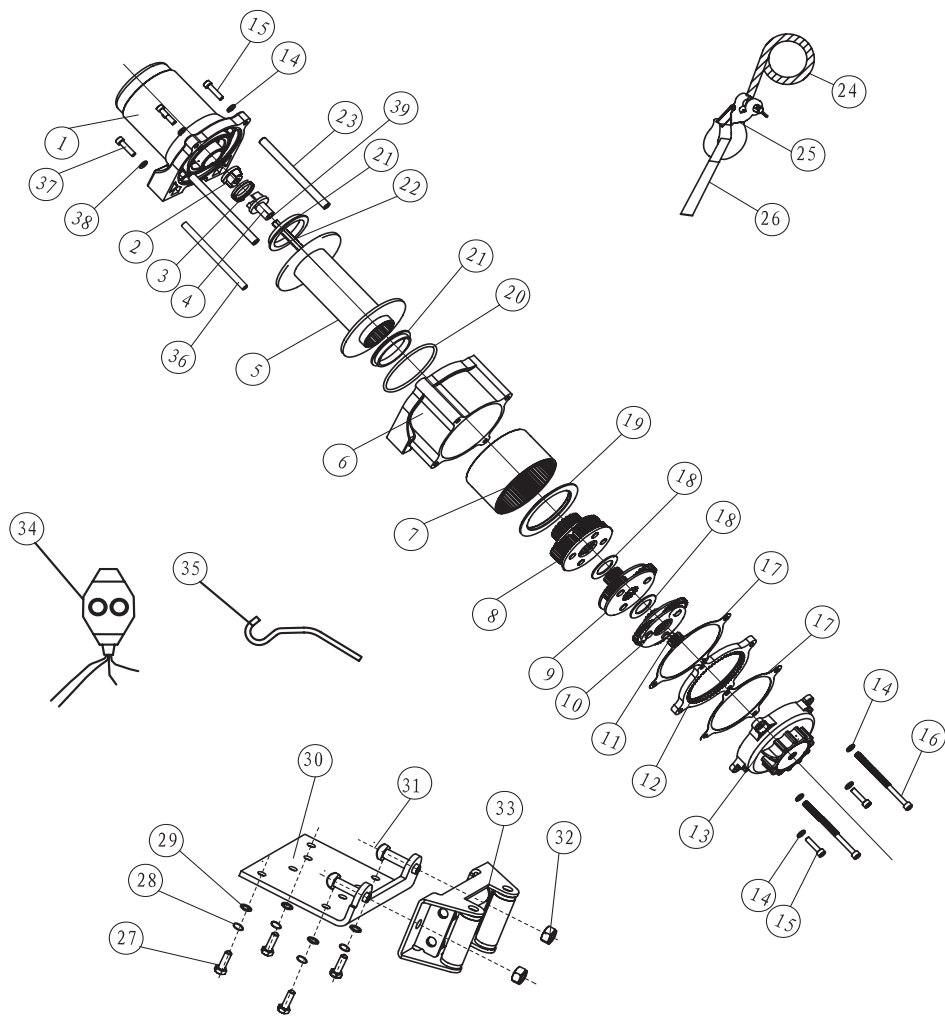

#	Part Number	Description	Qty
1	450100	Motor Assembly	1
2	450001	Coupling, I	1
3	450002	Spring, Coupling	1
4	450003	Coupling, II	1
5	450200	Drum Assembly	1
6	450004	Gear Housing / End Bearing	1
7	450005	Gear Ring	1
8	450006	Gear Carrier Assembly, Output	1
9	450007	Gear Carrier Assembly, Intermediate	1
10	450008	Gear Carrier Assembly, Input	1
11	450009	Gear - Input, Sun	1
12	450010	Gear, Fixed	1
13	450300	Clutch Assembly	1
14	250002	Washer 6, Flat	6
15	450011	Bolt M6x25	4
16	450012	Bolt M6x100	2
17	450013	Seal	2
18	450014	Friction Washer	2
19	450015	Retaining Ring	1

#	Part Number	Description	Qty
20	450016	O-Ring Seal	1
21	450017	Drum Bushing	2
22	450018	Hexagonal Shaft	1
23	450019	Tie Bar 10	2
24	450700	Cable Assembly	1
25	450020	1/4" Clevis Hook	1
26	300900	Strap	1
27	450021	Bolt M8x25	4
28	300020	Washer ø8, Locking	4
29	300019	Washer ø8, Flat	4
30	450022	Mounting Channel	1
31	450023	Bolt M10x20, Square Neck	2
32	250036	Locking Nut M10	2
33	450024	Roller Fairlead	1
34	450500	Switch Assembly	1
35	300022	Hand Saver Bar	1
36	450025	Tie Bar 8	1
37	450026	Bolt M4x25	2
38	450027	Washer 4, Flat	2
39	450029	Spring	1

TROUBLESHOOTING

Problem	Cause	Solution
Motor does not turn on	Loose battery cable connections	Tighten nuts on all cable connections.
	Defective Switch Assembly	Replace Switch Assembly.
	Defective motor	Check for voltage at armature port with Switch pressed. If voltage is present, Replace motor.
	Water has entered motor	Allow to drain and dry. Run in short bursts without load until completely dry.
Motor runs but Cable drum does not turn	Clutch not engaged	Move Clutch to the "In" position. If problem persists, a qualified technician needs to check and repair.
Motor runs slowly or without normal power	Insufficient current or voltage	The battery is weak, recharge. Run winch with vehicle motor running (Battery should have a strong charge)
	Loose or corroded battery cable connections.	Clean, Tighten, or replace.
Motor overheating	winch running time too long	Allow winch to cool down periodically.
Motor runs in one direction only	Defective Switch Assembly	Replace Switch Assembly.

For further technical support:

Technical Service

Mon – Fri 8:30 AM – 5:00 PM (PST/PDT)

Toll Free: 1 (877) 338-0999

tech@championpowerequipment.com

WARRANTY

CHAMPION POWER EQUIPMENT
2 YEAR LIMITED WARRANTY

Effective September 1, 2006. Replaces all undated warranties and all warranties dated before September 1, 2006.

Warranty Qualifications

Champion Power Equipment (CPE) will register this warranty upon receipt of your Warranty Registration Card and a copy of your sales receipt from one of CPE's retail locations as proof of purchase.

Please submit your warranty registration and your proof of purchase within ten (10) days of the date of purchase.

Repair/Replacement Warranty

CPE warrants to the original purchaser that the mechanical and electrical components will be free of defects in material and workmanship for a period of one year (parts and labor) and two years (parts) from the original date of purchase (90 days (parts and labor) and 180 days (parts) for commercial & industrial use). Transportation charges on product submitted for repair or replacement under this warranty are the sole responsibility of the purchaser. This warranty only applies to the original purchaser and is not transferable.

Do Not Return The Unit To The Place Of Purchase

Contact CPE's Technical Service and CPE will troubleshoot any issue via phone or e-mail. If the problem is not corrected by this method, CPE will, at its option, authorize evaluation, repair or replacement of the defective part or component at a CPE Service Center. CPE will provide you with a case number for warranty service. Please keep it for future reference. Repairs or replacements without prior authorization, or at an unauthorized repair facility, will not be covered by this warranty.

Warranty Exclusions

This warranty does not cover the following repairs and equipment:

Normal Wear

Winches need periodic parts and service to perform well. This warranty does not cover repair when normal use has exhausted the life of a part or the equipment as a whole.

Installation, Use and Maintenance

This warranty will not apply to parts and/or labor if this winch is deemed to have been misused, neglected, involved in an accident, abused, loaded beyond the winch's limits, modified, installed improperly or connected incorrectly to any electrical component. Normal maintenance is not covered by this warranty.

Other Exclusions

This warranty excludes: The winch cable. Cosmetic defects such as paint, decals, etc. Accessory parts such as storage covers. Failures due to acts of God and other force majeure events beyond the manufacturer's control. Problems cause by parts that are not original Champion Power Equipment parts.

Limits of Implied Warranty and Consequential Damage

Champion Power Equipment disclaims any obligation to cover any loss of time, use of this product, freight, or any incidental or consequential claim by anyone from using this winch. THIS WARRANTY IS IN LIEU OF ALL OTHER WARRANTIES, EXPRESS OR IMPLIED, INCLUDING WARRANTIES OF MERCHANTABILITY OR FITNESS FOR A PARTICULAR PURPOSE

A unit provided as an exchange will be subject to the warranty of the original unit. The length of the warranty governing the exchanged unit will remain calculated by reference to the purchase date of the original unit. This warranty gives you certain legal rights which may change from state to state. Your state may also have other rights you may be entitled to that are not listed within this warranty.

Contact Information

Address

Champion Power Equipment, Inc.
Customer Service
10006 Santa Fe Springs Rd.
Santa Fe Springs, CA 90670
www.championpowerequipment.com

Customer Service

Mon – Fri 8:30 AM – 5:00 PM (PST/PDT)
Toll Free: 1 (877) 338-0999
Fax no.: 1 (562) 236-9429

Technical Service

Mon – Fri 8:30 AM – 5:00 PM (PST/PDT)
Toll Free: 1 (877) 338-0999
tech@championpowerequipment.com